

## شكراً لتحميلك هذا الملف من موقع المناهج الإماراتية

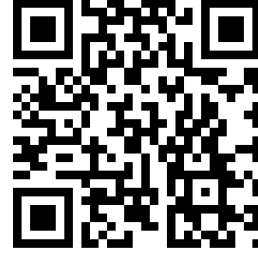

## حل أوراق عمل مراجعة وحدة energy of Types أنواع الطاقة

[موقع المناهج](#) ⇨ [المناهج الإماراتية](#) ⇨ [الصف الرابع](#) ⇨ [علوم](#) ⇨ [الفصل الثاني](#) ⇨ [الملف](#)

تاريخ نشر الملف على موقع المناهج: 11:56:19 2024-01-13

## التواصل الاجتماعي بحسب الصف الرابع



## روابط مواد الصف الرابع على تلغرام

[الرياضيات](#)

[اللغة الانجليزية](#)

[اللغة العربية](#)

[التربية الاسلامية](#)

## المزيد من الملفات بحسب الصف الرابع والمادة علوم في الفصل الثاني

<a href="#">أوراق عمل مراجعة وحدة energy of Types أنواع الطاقة</a>	1
<a href="#">أسئلة الامتحان النهائي - انسابير</a>	2
<a href="#">أسئلة الامتحان النهائي - بريدج</a>	3
<a href="#">مراجعة مترجمة وفق الهيكل الوزاري - انسابير</a>	4
<a href="#">حل أسئلة الامتحان النهائي - انسابير</a>	5



A multiple choice quiz. Tick the boxes to record the answer

1. A child hitting the drum creates vibrations that produce \_\_\_\_\_

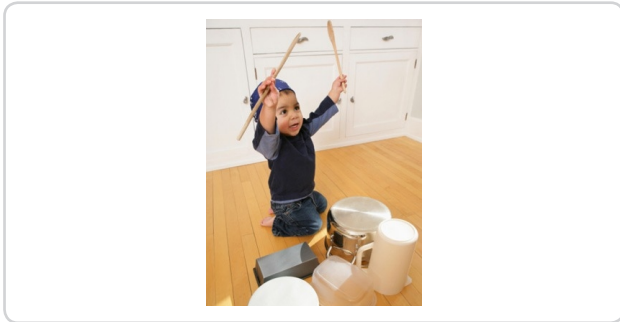

- A  Light energy
- B  Sound energy

2. When a person pluck string on a guitar , \_\_\_\_\_ energy is transferred.



- A  Sound
- B  Light

3. Which statement is true about LAMP?

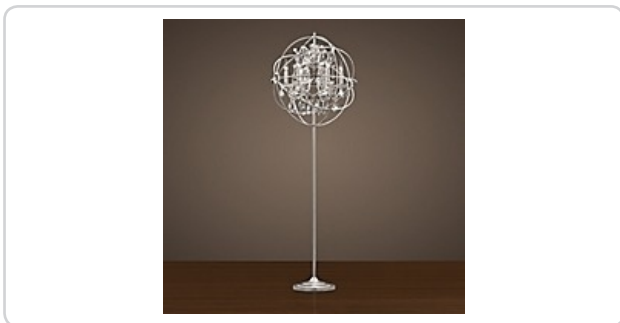

- A  Changes heat to electrical energy
- B  Changes light to electrical energy
- C  Changes electrical to light and heat energy
- D  You cannot change energy

4. Nuclear reactions in sun release \_\_\_\_\_

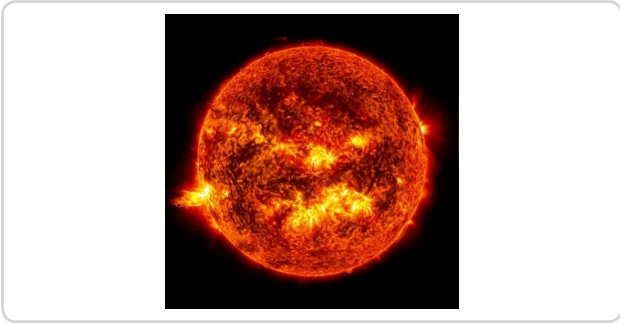

- A  Sound energy
- B  Nuclear energy

5. A fire truck siren and flashing lights are examples of

Select 2 answers



- A  Heat
- B  Light
- C  Sound
- D  Chemical

6. To stop a drum producing sound, you need to



- A  Hit it harder
- B  Hit it softer
- C  Stop it from vibrating
- D  Place it in water

7.



- A  Chemical energy
- B  Nuclear energy
- C  Light energy
- D  Electrical energy
- E  Sound energy
- F  Thermal energy

8.



- A  Chemical energy
- B  Nuclear energy
- C  Light energy
- D  Electrical energy
- E  Sound energy
- F  Thermal energy

9.



- A  Chemical energy
- B  Nuclear energy
- C  Light energy
- D  Electrical energy
- E  Sound energy
- F  Thermal energy

10.



- A  Chemical energy
- B  Nuclear energy
- C  Light energy
- D  Electrical energy
- E  Sound energy
- F  Thermal energy

11.



- A  Chemical energy
- B  Nuclear energy
- C  Light energy
- D  Electrical energy
- E  Sound energy
- F  Thermal energy

12.



- A  Chemical energy
- B  Nuclear energy
- C  Light energy
- D  Electrical energy
- E  Sound energy
- F  Thermal energy

13. How energy changes in the TOASTER?



- A  Chemical to thermal
- B  Electrical to light
- C  Electrical to thermal
- D  Electrical to chemical

14. Sunlight heats up the sidewalk

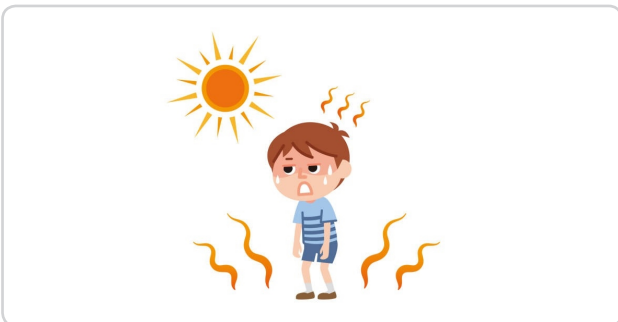

- A  Chemical to thermal
- B  Electrical to light
- C  Electrical to thermal
- D  Light to thermal

15. Battery powered flashlight



- A  Chemical to electrical
- B  Electrical to thermal
- C  Electrical to sound

16. The radio sitting on the table made the water in my glass move. Why?

- A  Some types of energy cannot transfer through water.
  - B  The sound energy of the radio transferred to the water
  - C  The electrical energy transferred through the water
  - D  Only light can move through water
- 

17. Burning wood



- A  Chemical energy
  - B  Light energy
- 

18. Plant use \_\_\_\_\_ energy to make food



- A  Light
  - B  Sound
  - C  Chemical
  - D  Electrical
- 

19. Phones convert electrical energy into\_\_\_\_\_.

Select 3 answers



- A  Thermal
- B  Light
- C  Sound
- D  Nuclear

20. Batteries have



- A  Light energy
- B  Sound energy
- C  Chemical energy
- D  Nuclear energy

21. Select ""stored"" energy

Select 2 answers

- A  Chemical energy
- B  Nuclear energy
- C  Electrical energy
- D  Light energy
- E  Thermal energy

22. Select ""Energy of motion""

Select 3 answers

- A  Chemical energy
- B  Nuclear energy
- C  Electrical energy
- D  Light energy
- E  Thermal energy

23. A pom pom lancer \_\_\_\_\_

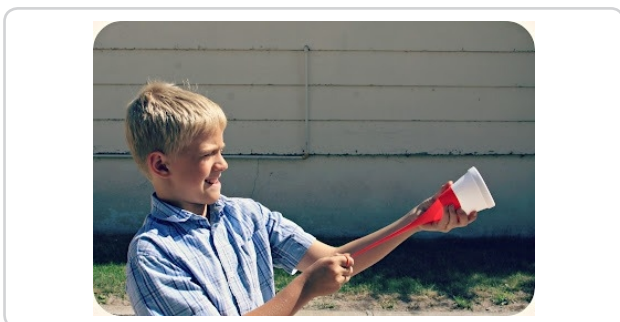

- A  kinetic energy to thermal energy
- B  kinetic energy to sound energy
- C  stored energy to energy of motion
- D  energy of motion to stored energy



24. When a student plays guitar, it reaches the ear in form of



- A  Echoes
- B  Potential energy
- C  Thermal energy
- D  Sound waves

25. You are asked to design a product that will change "electrical energy to heat energy".

- A  Hairdryer
- B  Alarm clock
- C  Ceiling fan
- D  Cell phone

26. You are watching fireworks. Fireworks give three forms of energy.



- A  Light,sound,electrical
- B  Light,sound,heat
- C  Sound,electrical,mechanical
- D  Heat,mechanical,electrical

27.

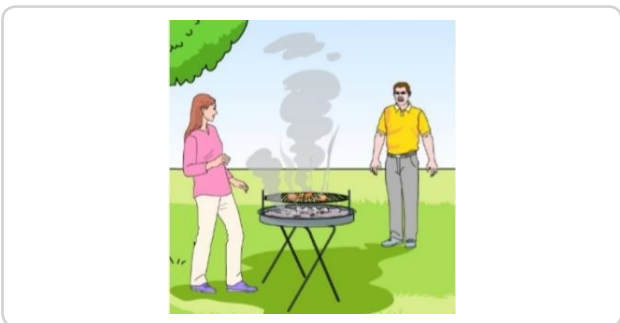

- A  The smoke shows that grills transferring heat energy to cook food.
- B  The smoke shows that grills transferring sound energy to cook food.
- C  The smoke shows that grills transferring electrical energy to cook food.
- D  The smoke shows that grills transferring mechanical energy to cook food.



28. Suppose you turn on a fan. Which energy conversion happens inside the motor.



- A  Electrical to motion
- B  Electrical to light
- C  Electrical to heat

29. Energy can be changed from one form to another. Which can change mechanical energy into electrical energy.

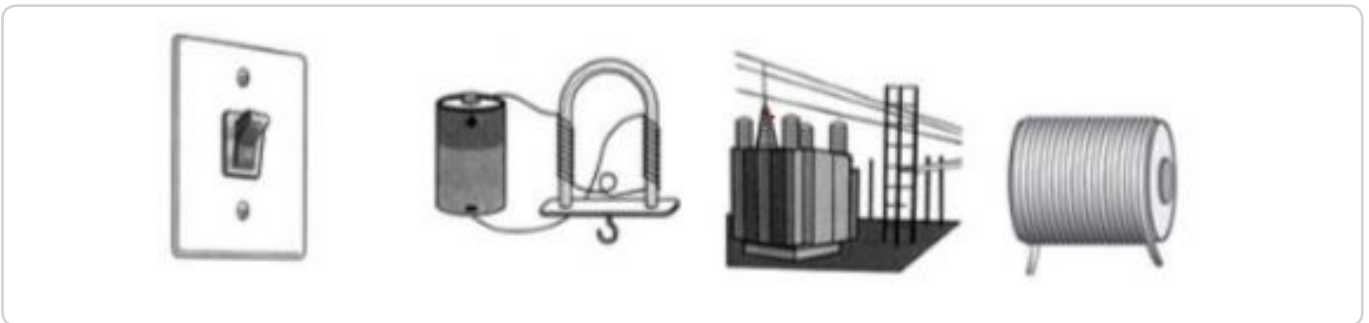

- A  Switch
- B  Electromagnet
- C  Transformer
- D  Generator

30. For a flashlight to turn on: CHEMICAL ENERGY--> ELECTRICAL ENERGY-->LIGHT ENERGY



- A  Energy transformations
- B  Energy exchange
- C  Energy being created
- D  Energy being destroyed



A multiple choice quiz. Tick the boxes to record the answer

1. When you pluck a string of guitar, it produce



A  Vibration      B  Light

2. Back and forth motion of an object is called



A  Vibration      B  Light

C  Thermal

3. Vibration produce



A  Light      B  Sound

C  Geothermal

4. A wave that transfer energy through a medium and spreads in all direction is called \_\_\_\_\_

A  Vibration      B  Light wave

C  Sound wave

5. Regions of air which that have many particles

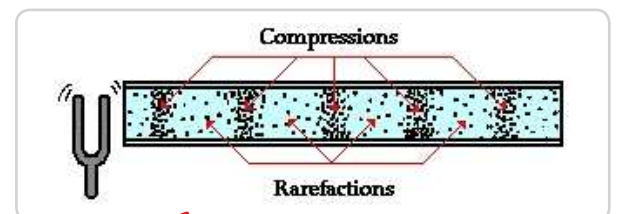

A  Compression      B  Rarefaction

6. Regions of air which have fewer particles

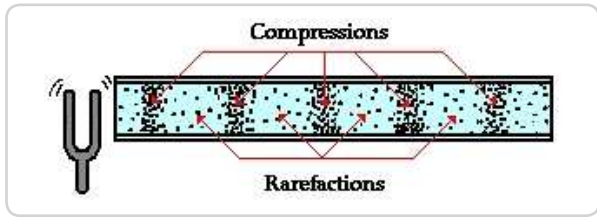

A  Compression B  Rarefaction

7. Sound wave is a series of \_\_\_\_\_ and \_\_\_\_\_

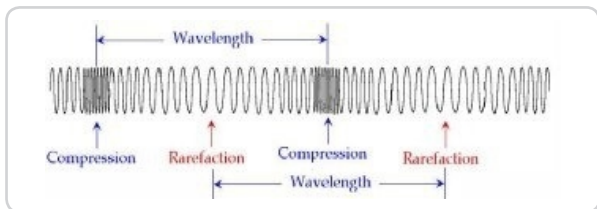

A  Compression and rarefactions  
B  Compression and depressions

8. 1 is \_\_\_\_\_

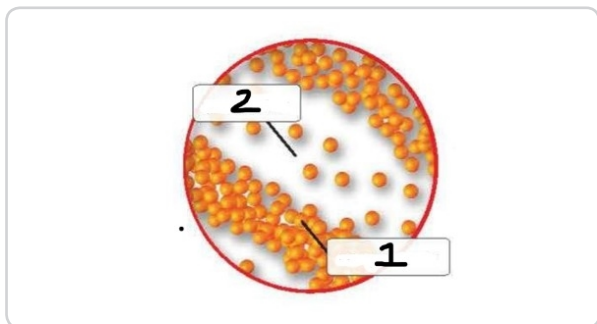

A  Compression B  Rarefaction

9. 2 is \_\_\_\_\_

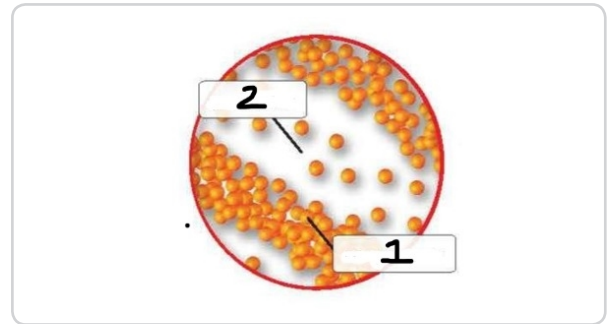

A  Compression B  Rarefaction

10. 1 is \_\_\_\_\_

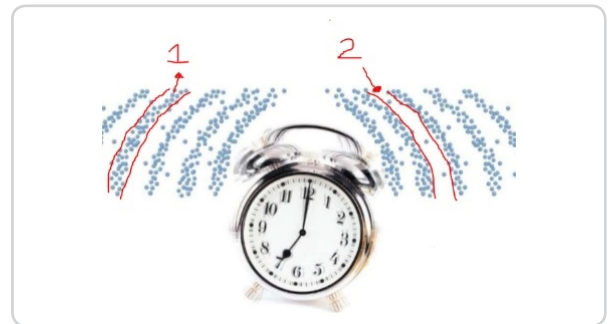

A  Compression B  Rarefaction

11. 2 is \_\_\_\_\_

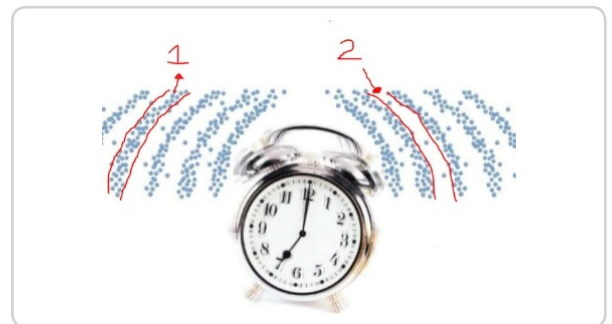

A  Compression B  Rarefaction

12. The substance through which wave travel is called \_\_\_\_\_

A  Medium B  Energy

13. Sound travel the fastest in \_\_\_\_\_

- A  Solids      B  Liquid  
C  Gas

14. Sound travel the slowest in \_\_\_\_\_

- A  Solids      B  Liquid  
C  Gas

15. Sound waves travels in the form of

- A  Longitudinal waves  
B  Transverse waves

16. Astronauts in space cannot talk to each other unless they use a radio to speak back and forth. Why is this?

- A  The air is too thick to carry sound waves efficiently.  
B  The force of gravity is too strong to allow sound waves to travel.  
C  There is no air in space, so there is no medium to carry sound waves.  
D  It is very loud in space, so they can only hear each other through a radio.

17. Why are sounds not heard in space?

- A  Space is too cold for sound waves to travel.  
B  There is too much matter to travel through in space.  
C  Space is a vacuum with few particles to travel through.  
D  Energy cannot travel in space.

18. Sound \_\_\_\_\_ travel through outer space.

- A  does      B  does not

19. How does sound energy travel?

- A  in strings      B  in beams  
C  in pulses      D  in waves

20. A form of energy that allows you to see objects is \_\_\_\_\_.

- A  Heat      B  Light  
C  Solar energy      D  Vision

21. Light travels as tiny \_\_\_\_\_ of energy.

- A  Particles      B  Pressure

22. A pom-pom launcher \_\_\_\_\_

- A  transfers kinetic energy to thermal energy
- B  transforms kinetic energy to sound energy
- C  transforms stored energy to energy of motion
- D  transfers energy of motion to stored energy

23. \_\_\_\_\_ cells are devices that use light from the sun to make electricity

- A  Solar
- B  Wind

24. Solar cell are called \_\_\_\_\_

- A  Photovoltaic cells
- B  Phonovoltaic

25. Identify the statement that correctly explains what happens when energy transfers in a system.

- A  About 75% of the energy is transferred, while the rest is destroyed.
- B  All of the energy is transferred in different amounts to different forms.
- C  Half of the energy is transferred in different amounts to different forms.
- D  Some of the energy gets transferred, while a portion is lost along the way.

26. Thermal energy is

- A  the internal energy of an object due to the kinetic energy of its particles
- B  the external energy of an object due to its potential energy
- C  the internal energy of an object due to the stored energy of its particles
- D  the external energy of an object due to its exposure to the Sun

27. Sound energy is a type of

- A  Stored energy
- B  Infrared energy
- C  Energy of motion
- D  None of the above

28. Solar cells convert light energy into \_\_\_\_\_ energy

- A  Electrical energy
- B  Sound energy

29.



- A  Solar cell
- B  Battery

30. Solar cells need \_\_\_\_\_ energy

A  Sound energy

B  Light energy

# HEAT

Name: \_\_\_\_\_



A multiple choice quiz. Tick the boxes to record the answer

1. Heat always transfers from \_\_\_\_\_ to \_\_\_\_\_

A  Warmer, Colder

B  Colder, Warmer

2. Heat always transfers from \_\_\_\_\_ to \_\_\_\_\_

A  Hot, Cold

B  Cold, Hot

3. A \_\_\_\_\_ transfers heat easily.

A  conductor

B  insulator

4. Danny did an experiment where he observed that a hot pan is best held by a dry oven mitt. When the oven mitt was wet, the hot pan almost burned Danny's hand. This is an example of \_\_\_\_\_ being transferred by heat.



A  Energy

B  Water

5. \_\_\_\_\_ is excellent thermal conductor

A  Wood

B  Plastic

C  Aluminium

6.



A  Conduction

B  Convection

C  Radiation

7.



A  Conduction

B  Convection

C  Radiation



8. You are watching fireworks on the fourth of July. When the fireworks are set off, they give off three forms of energy. Which three forms of energy are given off?



- A  light, sound, electrical  
B  light, sound, heat  
C  sound, electrical, mechanical  
D  heat, mechanical, electrical

9.

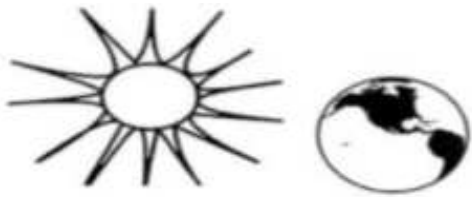

- A  Conduction    B  Convection  
C  Radiation

10.

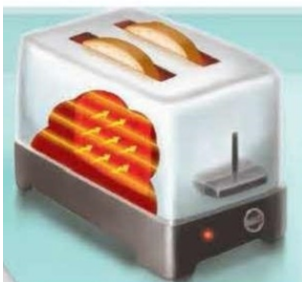

- A  Conduction    B  Convection  
C  Radiation

11. When heat transfers when two objects are touching

- A  Conduction    B  Convection  
C  Radiation

12. When heat transfers without touching

- A  Conduction    B  Convection  
C  Radiation

13. When heat transfers through liquid and gas

- A  Conduction    B  Convection  
C  Radiation

14.

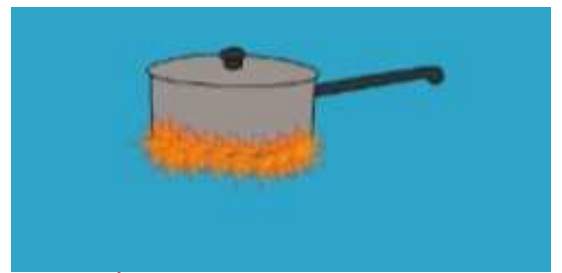

- A  Conduction    B  Convection  
C  Radiation

15.



- A  Conduction    B  Convection  
 C  Radiation

18.



- A  Conduction    B  Convection  
 C  Radiation

16.



- A  Conduction    B  Convection  
 C  Radiation

19.



- A  Incandescent bulb    B  LED bulb

17.



- A  Conduction    B  Convection  
 C  Radiation

20.



- A  Incandescent bulb    B  LED bulb

21. Which bulbs waste a lot of thermal energy?

A   Incandescent bulb

B   LED bulb

22. Which bulbs become very hot?

A   Incandescent bulb

B   LED bulb

23. Which bulb is good for saving electricity?

A   Incandescent bulb

B   LED bulb

24. Which bulb lasts up to 20 years and wastes less energy?

A   Incandescent bulb

B   LED bulb

25. Incandescent lightbulb transfer most energy into



A   Heat

B   Light

26. Heat is the movement of energy from \_\_\_\_\_

A  Warmer object to colder object

B  Colder object to warmer object

27. LED bulb transfer most energy into



A   Heat

B   Light

28.

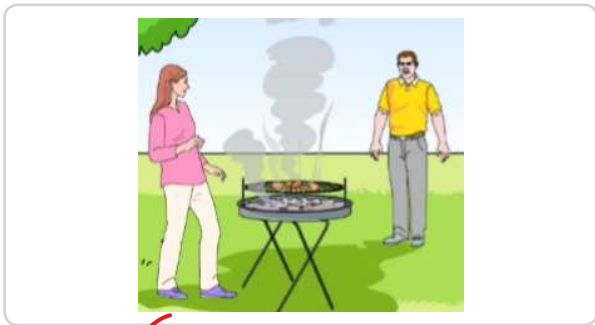

A  The smoke shows that the grill is transferring heat energy to cook the food.

B  The smoke shows that the grill is transferring sound energy to cook the food.

C  The smoke shows that the grill is transferring electrical energy to cook the food.

D  The smoke shows that the grill is transferring mechanical energy to cook the food.

29. It is very hot outside and you walk barefoot on hot pavement. Predict what will happen in this scenario.



A  The transfer of heat energy from the pavement will cause your feet to feel hot.

B  The transfer of light energy from the pavement will cause your feet to feel hot.

C  The transfer of light energy from the pavement will cause your feet to feel cold.

D  The transfer of heat energy from the pavement will cause your feet to feel cold.

30. A farmer needed to keep his baby chicks warm. He placed a light in their cage. Which sentence best explains the farmer's thinking of placing a light in the cage?



- A  The farmer thought the light would transfer thermal energy to the chicks' cage.
- B  The farmer thought that the chicks would be healthier if they were not in the dark.
- C  The farmer thought that the chicks would eat more to stay warm if they can see their food.
- D  The farmer thought that the light would encourage the chicks to huddle together to keep themselves warm

# Electricity

Name: \_\_\_\_\_



A multiple choice quiz. Tick the boxes to record the answer

1. Flow of electricity through a conductor

- A  Current      B  Convection  
C  Conduction

2. Material through which electricity can flow easily

- A  Conductor      B  Insulator

3. Material through which electricity cannot flow easily

- A  Conductor      B  Insulator

4. Metal is \_\_\_\_\_



- A  Conductor      B  Insulator

5. Plastic is \_\_\_\_\_



- A  Conductor      B  Insulator

6. A path along which electric current flows is called a(n) \_\_\_\_\_

- A  Circuit      B  Resistor

7. An object which resists the flow of energy

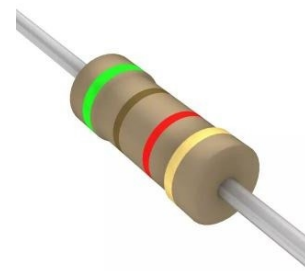

- A  Circuit      B  Resistor

8. A fan is plugged into an extension cord. The extension cord is plugged into a wall outlet. How does the extension cord help the fan work?



- A  The extension cord makes the fan more powerful.
- B  The extension cord makes the fan easier to operate.
- C  The extension cord transfers sound energy to the fan.
- D  The extension cord transfers electric currents from the outlet to the fan.

9. A flow of electrical charges is known as \_\_\_\_.

- A  resistance
- B  electrical current
- C  static electricity
- D  voltage

10. An electric fence used to contain cattle works by transmitting energy through a conductor creating an electric \_\_\_\_\_.

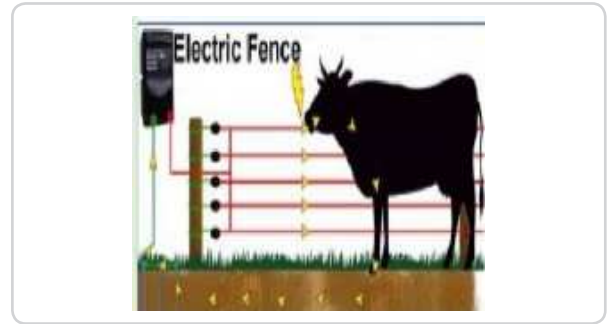

- A  Light
- B  Sound
- C  Current

11. In an electric circuit, a battery can act as a \_\_\_\_\_.

- A  voltage source
- B  conductor
- C  insulator
- D  resistor

12. A conductor is a

- A  a material that increases the number of charged particles
- B  material that increases the amount of electricity
- C  material through which electricity flows easily
- D  material that stops the flow of energy



13. A switch in a circuit \_\_\_\_\_.



- A  acts as an insulator
- B  absorbs electricity
- C  allows or stops the flow of electricity
- D  keeps the flow of electricity at a safe level

14. An object in an electrical circuit that resists the flow of energy is called \_\_\_\_\_.

- A  a magnet
- B  a compass
- C  a voltage
- D  a resistor

15. A student made the circuit .  
What does the student need to add to make the circuit work?

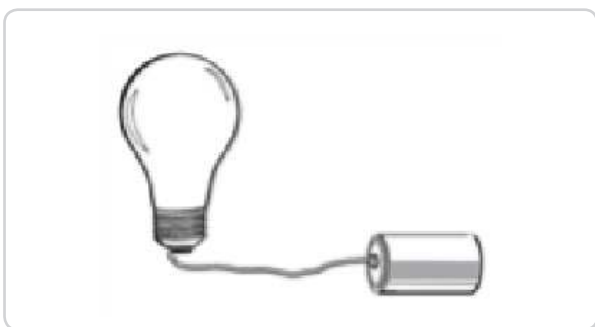

- A  Another bulb
- B  Another battery
- C  Switch
- D  Another wire

16. Amy touched a machine called a Van de Graaf generator. When she touched the generator all of her hair on the top of her head stood up. When she removed her hand from the generator, her hair fell back to its normal state. What conclusion can you draw from Amy touching the generator?

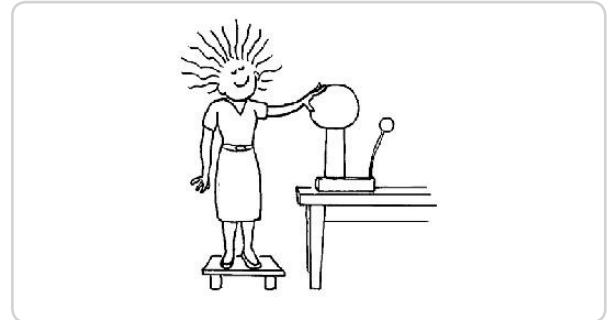

- A  Charged particles are being pulled from the air.
- B  Charged particles are being pulled from the floor.
- C  Charged particles are being destroyed.
- D  Charged particles are being moved from one object to another.

17.

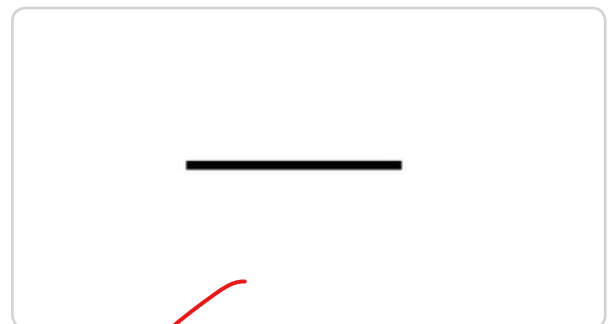

- A  Wire
- B  Resistor
- C  Voltage source

18. This is \_\_\_\_\_

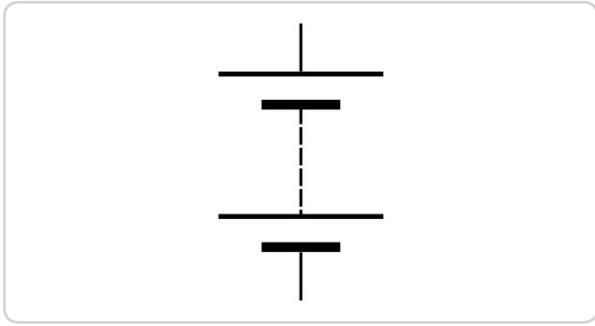

- A  Wire      B  Resistor  
C  Voltage source

19. This is \_\_\_\_\_



- A  Wire      B  Resistor  
C  Voltage source

20.

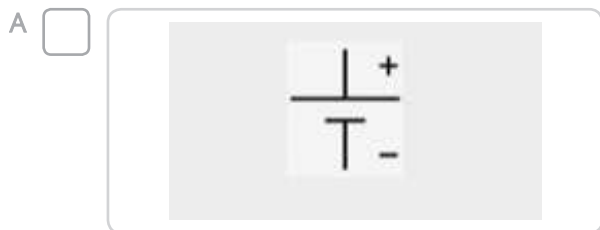

21.

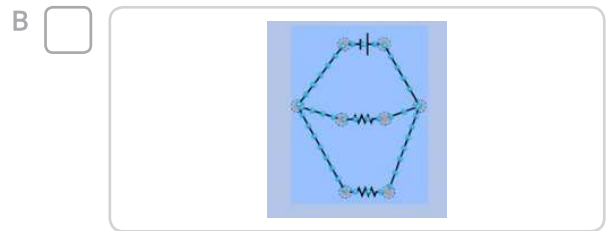
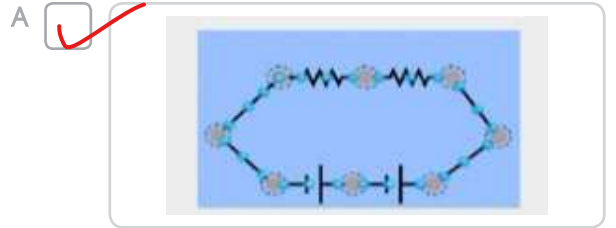
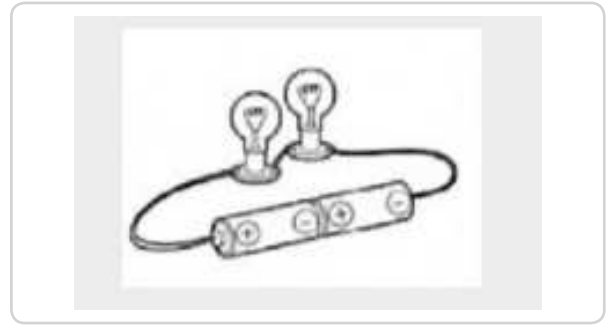

22.

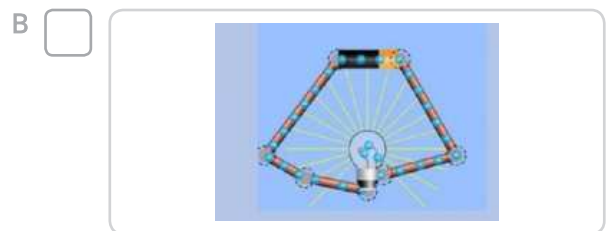
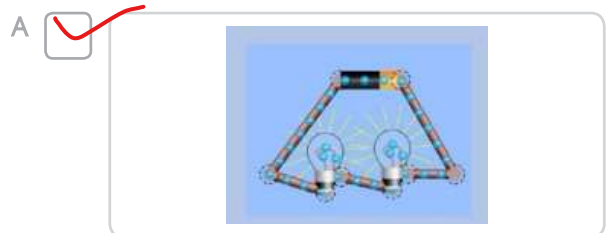
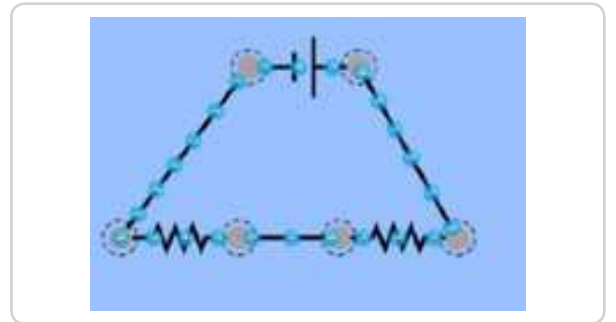

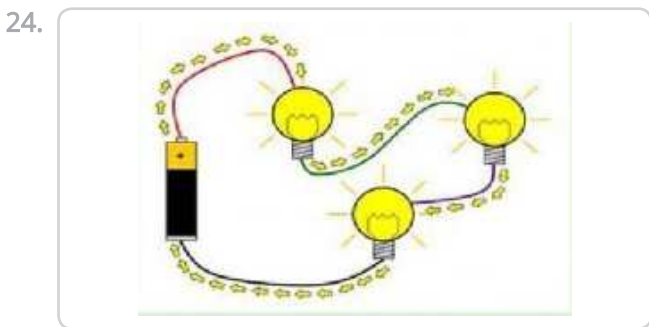
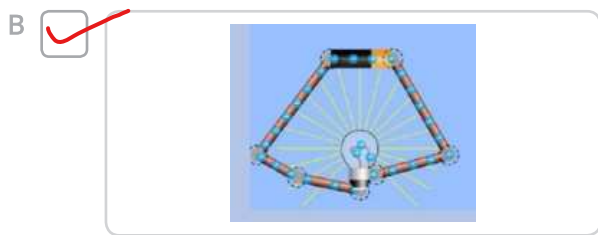
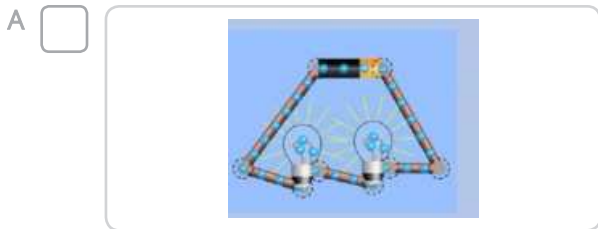
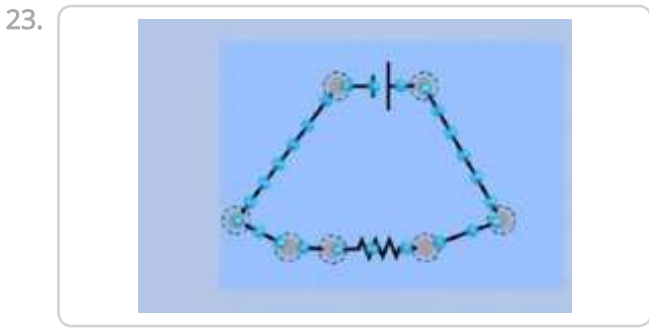

- A  Series circuit      B  Parallel circuit

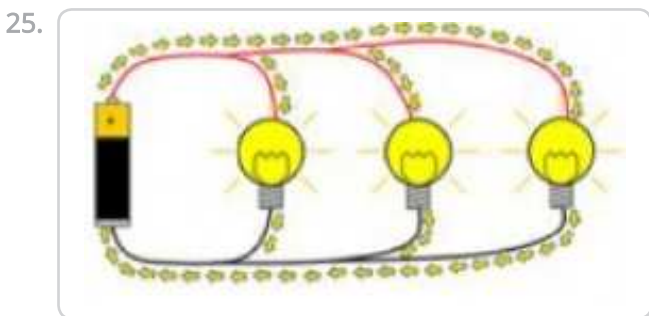

- A  Series circuit      B  Parallel circuit

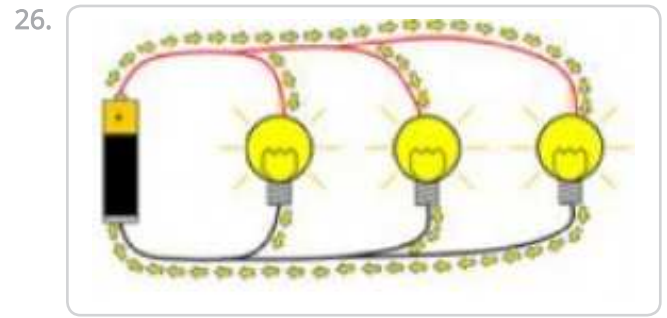

- A  Current flows in many path  
B  Current flows in one path

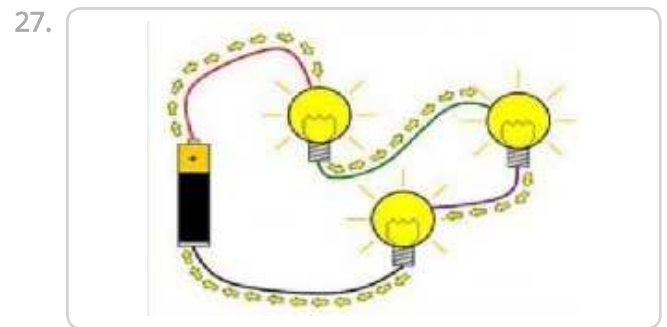

- A  Current flows in many path  
B  Current flows in one path

28. Which circuit we have in our home and school

- A  Series circuit      B  Parallel circuit

29. Which circuit is the BEST to use?

- A  Series circuit  
B  Parallel circuit

30.

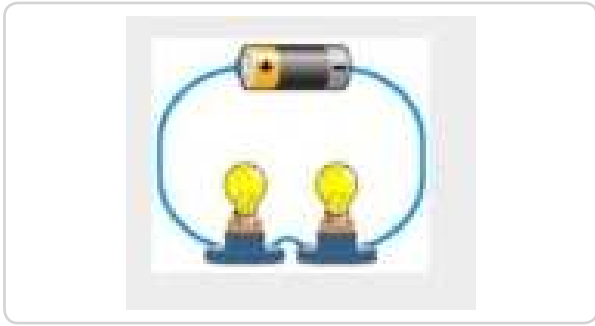

A  Open circuit

B  Closed circuit

31.

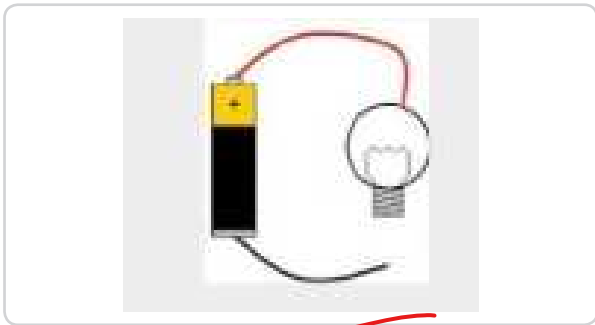

A  Open circuit

B  Closed circuit

32.



A  Series circuit

B  Parallel circuit

33.



A  Series circuit

B  Parallel circuit

34.

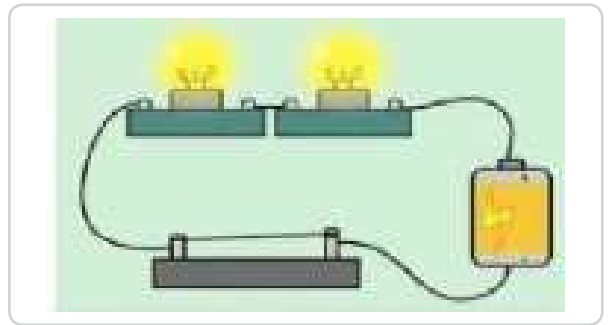

A  Series circuit

B  Parallel circuit

35.

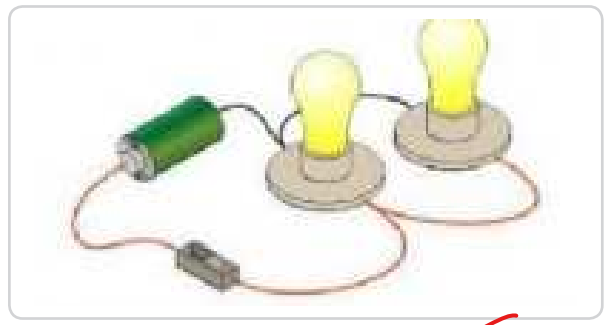









A  Series circuit

B  Parallel circuit

# Renewable and Non-Renewable Resources

Name: \_\_\_\_\_

Tick the box to show which group each item is in

	Renewable Resources	Non-Renewable Resources		Renewable Resources	Non-Renewable Resources
1. Hydropower 	<input checked="" type="checkbox"/>	<input type="checkbox"/>	5. Oil 	<input type="checkbox"/>	<input checked="" type="checkbox"/>
2. Nuclear Energy 	<input type="checkbox"/>	<input checked="" type="checkbox"/>	6. Solar 	<input checked="" type="checkbox"/>	<input type="checkbox"/>
3. Coal 	<input type="checkbox"/>	<input checked="" type="checkbox"/>	7. Wind 	<input checked="" type="checkbox"/>	<input type="checkbox"/>
4. Natural Gas 	<input type="checkbox"/>	<input checked="" type="checkbox"/>	8. Geothermal 	<input checked="" type="checkbox"/>	<input type="checkbox"/>

# RENEWABLE RESOURCES

Name: \_\_\_\_\_

Draw a line to connect each pair of boxes

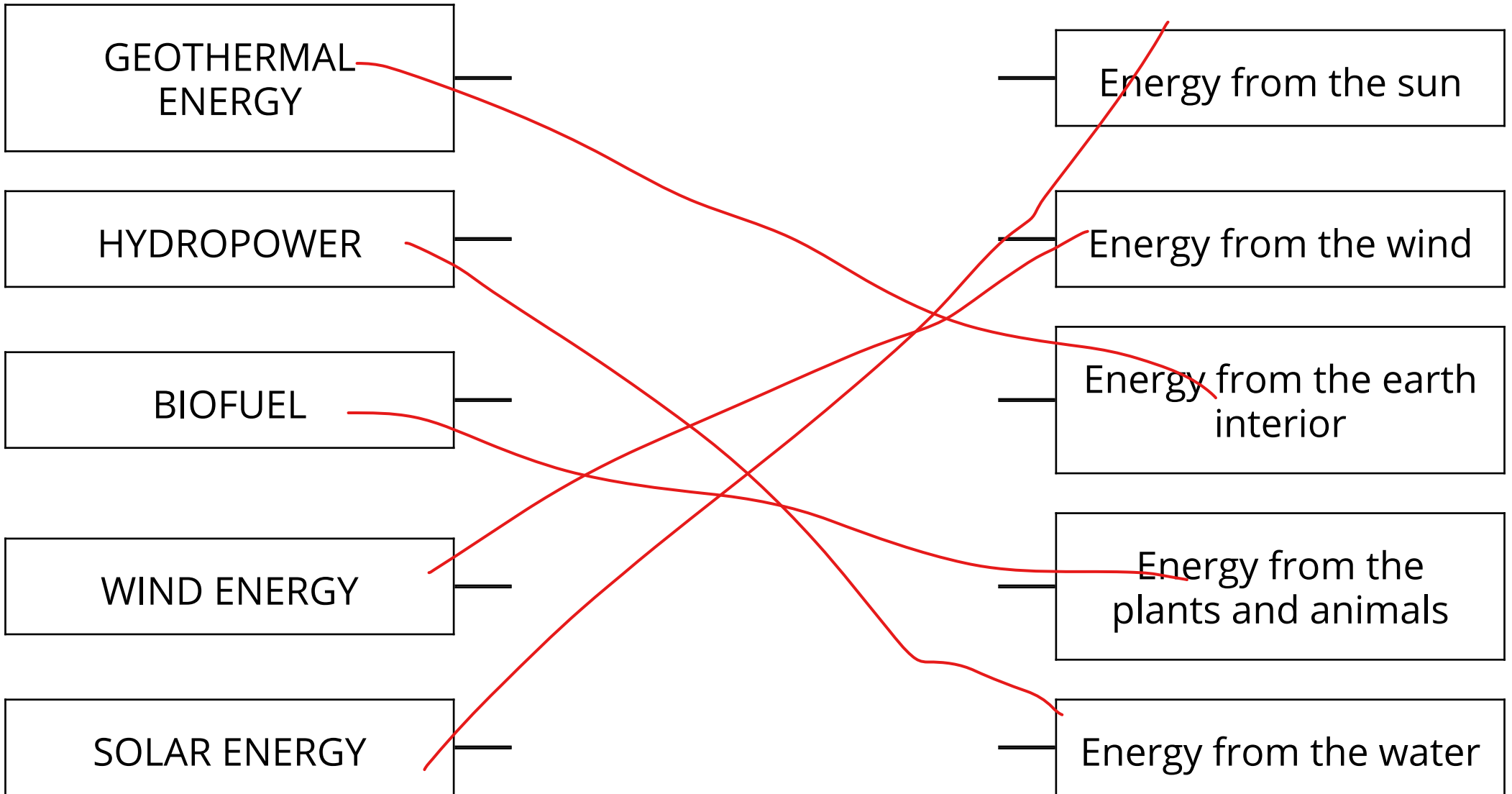

# RENEWABLE RESOURCES

Name: \_\_\_\_\_

1. Energy from the sun

- A  SOLAR ENERGY  
B  WIND ENERGY  
C  GEOTHERMAL ENERGY  
D  HYDROPOWER

2. Energy from the wind

- A  BIOFUEL                      C  HYDROPOWER  
B  SOLAR ENERGY      D  WIND ENERGY

3. Energy from the earth interior

- A  HYDROPOWER  
B  GEOTHERMAL ENERGY  
C  WIND ENERGY  
D  SOLAR ENERGY

4. Energy from the plants and animals

- A  SOLAR ENERGY  
B  GEOTHERMAL ENERGY  
C  WIND ENERGY  
D  BIOFUEL

5. Energy from the water

- A  GEOTHERMAL ENERGY  
B  SOLAR ENERGY  
C  BIOFUEL  
D  HYDROPOWER

6.



- A  HYDROPOWER      D  SOLAR  
B  GEOTHERMAL      E  BIOFUEL  
C  WIND

7.



- A  HYDROPOWER      D  SOLAR  
B  GEOTHERMAL      E  BIOFUEL  
C  WIND

8. Wood, crops and animal waste is called

- A  Airmass                      B  Biomass

9. Select renewable resource

Select 3 answers

- A  Air                                      D  Coal  
B  Water                                      E  Gas  
C  Wind                                      F  Crude Oil

10. Geothermal energy is obtained and used by harnessing the heat from \_\_\_\_\_ Earth's surface.

- A  Above                                      B  Below



## 2- RENEWABLE RESOURCES

Name: \_\_\_\_\_

1. A device that produces electricity from sunlight is a(n)\_\_\_\_\_

- A  Solar cell      B  Dry cell

2. hydroelectric plant uses alternative energy sources, such as\_\_\_\_, to generate electricity.

- A  Wind      B  Water

3.



Which type of energy would best be used in an area with a lot of hot springs?

- A  hydroelectricity  
B  solar energy  
C  wind energy  
D  geothermal energy

4. Wind energy, water energy, and solar power are all examples of\_\_\_\_\_energy solutions.

- A  Renewable or alternate resources  
B  Non renewable

5. Which is not a source of renewable energy?

- A  thermal energy    C  solar energy  
B  wind energy      D  fossil fuels

6. Wind energy, harnessed by windmills, is one type of \_\_\_\_\_ energy source.

- A  nonrenewable    B  renewable

7. Because it can be replaced quickly in nature, water is considered a(n)

- A  nonrenewable    B  renewable

8. Which method is used to change plant and animal materials into usable fuel?

- A  hydroelectricity  
B  recycling  
C  biomass conversion  
D  solar collection

9.



- A  BIOFUEL  
B  WIND ENERGY  
C  GEOTHERMAL ENERGY

10.



- A  BIOFUEL  
B  WIND ENERGY  
C  GEOTHERMAL ENERGY

# 1-Non-Renewable resources

Name: \_\_\_\_\_

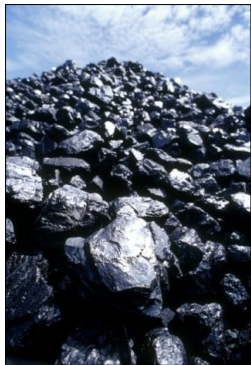
- Fossils fuels are  
A  nonrenewable resources  
B  renewable resources  
C  unlimited resources  
D  inexpensive resources
- How are fossil fuels formed?  
A  Heat and pressure turn animal and plant remains into fuels.  
B  Scientists collect fossils and turn them into fuels.  
C  On the surface of Earth, wind and rain turn fossils into fuels.  
D  Fossils sink into swamps and take between five and ten years to turn into fuels.
- \_\_\_\_\_ is pumped out of the ground and can be used for cooking and heating our homes  
A  Crude Oil      B  Natural Gas
- Which is not a fossil fuel?  
A  Oil      C  Wood  
B  Natural gas      D  Coal
- A material that formed from ancient organisms and is used today as a source of energy is \_\_\_\_\_  
A  fossil fuel  
B  sediment  
C  alternative energy resource
- Which is an example of a nonrenewable resource?  
A  Wind      C  Oil  
B  Sunlight      D  Water
- Coal is mainly used to generate \_\_\_\_\_ and has been used to power steam locomotives.  
A  Electricity      B  Sound energy
- Corn, crabs, natural gas, and soybeans are natural resources found in Maryland. Which is a nonrenewable resource?  
A  Corn      C  Soybeans  
B  Crabs      D  Natural Gas
- Nonrenewable resources are resources that \_\_\_\_\_.  
A  take so long to form that they cannot be replaced quickly  
B  are so plentiful in nature that they can be used without worry  
C  cause no pollution to the environment, so they are the best kind to use  
D  cause so much pollution that they are never used
-   
Coal is a nonrenewable natural resource. Which best describes how humans use coal?  
A  Humans use coal for food.  
B  Humans use coal for clothing.  
C  Humans use coal for medicine.  
D  Humans use coal to produce electricity.

## 2-Non-Renewable resources

Name: \_\_\_\_\_

1. Select all the natural resources

Select 5 answers

- A  Air      C  Tyre      E  Minerals  
 B  Coal      D  Rocks      F  Plants

2. Natural resource is something found in \_\_\_\_\_

- A  Nature and valuable to humans  
 B  Nature and invaluable to humans

3. Non renewable resources

- A  Cannot be replaced quickly.  
 B  Can be replaced quickly.

4. What is fossil fuels?

- A  Source of energy made from the remains of ancient living organisms.  
 B  Made from gas

5. Select fossil fuels.

Select 3 answers

- A  Coal      C  Petroleum      E  Wind  
 B  Natural gas      D  Sun

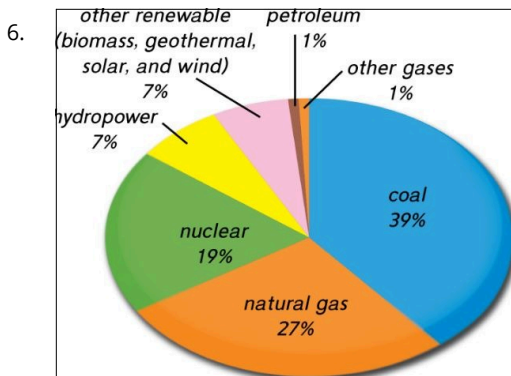

Based on the "Sources of Electricity" pie graph, what is the total percentage of nonrenewable resources that are used to generate electricity?

- A  86%      B  100%      C  67%      D  15%

7.



Crude oil is

- A  Non renewable resources  
 B  Renewable resource

8. Select non renewable resource

Select 4 answers

- A  petroleum  
 B  natural gas  
 C  coal  
 D  uranium(nuclear gas)  
 E  Plants  
 F  Wind

9. Coal is used to power

- A  Locomotives and steamboats



- B  Car



10.



Natural gas is used mainly

- A  For cooking and heating homes  
 B  For making electricity

# 1-IMPACT OF ENERGY USE

Name: \_\_\_\_\_

1. Fossil fuels used in transportation can cause problems. Which is a possible solution to these problems?

- A  Use renewable energy sources in cars, such as biofuels and solar power.
- B  Have car and truck drivers use more fossil fuels in their vehicles during rush hour traffic
- C  Make hybrid cars, which use both gas and electricity, illegal.
- D  Do not build fuel-efficient cars.

2. When an item is \_\_\_\_\_, it is made into a new product.

- A  Reduce
- B  Reuse
- C  Recycle

3. Using something twice

- A  Reduce
- B  Reuse
- C  Recycle

4. Lessening the amount of something that is used.

- A  Reduce
- B  Reuse
- C  Recycle

5. Which is not a source of renewable energy?

- A  Geothermal energy
- B  wind energy
- C  solar energy
- D  fossil fuels

6.

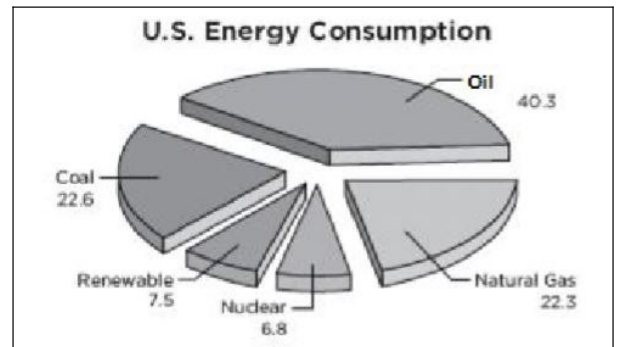

What percentage of the energy resources used by Americans comes from fossil fuels?

- A  7.5 %
- B  40.3 %
- C  85.2 %
- D  93.2 %

7. Burning oil as fuel can release harmful substances called \_\_\_\_\_

- A  pollution
- B  Electricity

8. Our society uses up vast amounts of nonrenewable sources of energy. What should we do about energy sources in the future?

- A  Nothing; all energy sources are replaceable.
- B  We will need to develop new ways of using oil.
- C  We will need to develop more technology that relies on fossil fuels.
- D  We will need to find ways to use renewable sources of energy.

9. The overuse of fossil fuels leads to \_\_\_\_\_.

- A  flooding
- B  pollution
- C  fertile soil
- D  good crops

10. Reducing the amount of resources we use, called \_\_\_\_\_, will allow resources to be saved for a later time

- A  Consumption
- B  conservation

# Reduce, Reuse, and Recycle

Name: \_\_\_\_\_

Tick the box to show which group each item is in

- |   | Reduce                              | Reuse                               | Recycle                             |  | Reduce                              | Reuse                               | Recycle                             |
|---|-------------------------------------|-------------------------------------|-------------------------------------|--|-------------------------------------|-------------------------------------|-------------------------------------|
| 1. I turn off the water when I brush my teeth.                                      | <input checked="" type="checkbox"/> | <input type="checkbox"/>            | <input type="checkbox"/>            | 7. I put plastic in the recycling container instead of in the garbage.               | <input type="checkbox"/>            | <input type="checkbox"/>            | <input checked="" type="checkbox"/> |
|    |                                     |                                     |                                     |    |                                     |                                     |                                     |
| 2. I refill my water bottle instead of throwing it away.                            | <input type="checkbox"/>            | <input checked="" type="checkbox"/> | <input type="checkbox"/>            | 8. I put paper in the recycling container instead of in the garbage.                 | <input type="checkbox"/>            | <input type="checkbox"/>            | <input checked="" type="checkbox"/> |
|    |                                     |                                     |                                     |     |                                     |                                     |                                     |
| 3. I put cans in the recycling container instead of in the garbage.                 | <input type="checkbox"/>            | <input type="checkbox"/>            | <input checked="" type="checkbox"/> | 9. I take shorter showers.   | <input checked="" type="checkbox"/> | <input type="checkbox"/>            | <input type="checkbox"/>            |
|  |                                     |                                     |                                     |   |                                     |                                     |                                     |
| 4. I use a lunchbox instead of a paper bag.   | <input type="checkbox"/>            | <input checked="" type="checkbox"/> | <input type="checkbox"/>            | 10. I walk to school instead of driving.   | <input checked="" type="checkbox"/> | <input type="checkbox"/>            | <input type="checkbox"/>            |
|  |                                     |                                     |                                     |  |                                     |                                     |                                     |
| 5. I turn off the lights when I leave the room.                                     | <input checked="" type="checkbox"/> | <input type="checkbox"/>            | <input type="checkbox"/>            | 11. I write on the back of my paper instead of getting a new one.                    | <input type="checkbox"/>            | <input checked="" type="checkbox"/> | <input type="checkbox"/>            |
|  |                                     |                                     |                                     |  |                                     |                                     |                                     |
| 6. I put cardboard boxes in the recycling container instead of in the garbage.      | <input type="checkbox"/>            | <input type="checkbox"/>            | <input checked="" type="checkbox"/> | 12. I donate my old clothes for others to use them.                                  | <input type="checkbox"/>            | <input checked="" type="checkbox"/> | <input type="checkbox"/>            |
|  |                                     |                                     |                                     |  |                                     |                                     |                                     |

# MC GRAW HILL QUESTIONS

Date: \_\_\_\_\_

Name: \_\_\_\_\_



Select the correct option:

1. Biomass conversion generates energy from \_\_\_\_\_

- A  Plants and animal waste    B  Running water    C  Sunlight    D  Moving air

2. Fossil fuels are a \_\_\_\_\_ resource.

- A  Renewable    B  Non renewable resource

3. Wind, moving water, solar energy, nuclear energy and geothermal energy are all \_\_\_\_\_

- A  Non renewable resources    B  Free energy sources    C  Fossil fuels    D  Renewable resources

4. Which is NOT a resource that is burned to heat our homes and give us electricity.

- A  Natural gas    B  Coal    C  Plastic    D  Oil

5. Where does geothermal energy comes from?

- A  Inside earth    B  Sun    C  Wind turbines    D  Hydroelectric dams

6. Lily learned that fossil fuels contain lots of energy. Why are fossils known as non renewable?

- A  It is essential for civilization.    B  It cannot be replaced fast enough for future use.    C  They are easily renewed.    D  They are alternative energy sources.

7. Geothermal power plants use \_\_\_\_\_ from the earth interior to generate power.

- A  Heat    B  Sound    C  Light

8. Which of the following are renewable resources?

Select 2 answers

A  Fossil fuels

B  Hydroelectricity

C  Wind energy

D  Copper

9. The act of saving ,protecting or using resources wisely is called\_\_\_\_\_

A  Reservation

B  Generation

C  Conservation

D  Production

10. Energy from running water is used to generate

A  Static Electricity

B  Hydroelectricity

11. Which of the following is not an advantage to renewable energy?

A  Solar power is abundant as a resource.

B  Hydroelectric dams block river and streams.

C  Biomass energy uses waste products to create energy.

D  Wind energy can be generated day and night.

12. Why is solar power a renewable energy resource?

A  It cannot be used up.

B  It is a natural resource.

C  It creates extra sunlight.

D  It creates new sources of gasoline.

13. What is one effect of using COAL to meet our energy needs?

A  It cleans the air.

B  It will not run out.

C  It doesnot disturb the wildlife.

D  It pollutes the environment.

14. Which statement is NOT TRUE about Nuclear energy?

A  Nuclear energy is created using fossil fuels.

B  Nuclear energy is a non renewable resource.

C  Nuclear energy is used to generate electricity.

D  Nuclear energy waste may damage the environment.