

تم تحميل هذا الملف من موقع المناهج الإماراتية



موقع
المناهج الإماراتية

www.alManahj.com/ae

*للحصول على أوراق عمل لجميع الصفوف وجميع المواد اضغط هنا

<https://almanahj.com/ae>

* للحصول على أوراق عمل لجميع مواد الصف السادس اضغط هنا

<https://almanahj.com/ae/6>

* للحصول على جميع أوراق الصف السادس في مادة تصميم ولجميع الفصول, اضغط هنا

<https://almanahj.com/ae/6design>

* للحصول على أوراق عمل لجميع مواد الصف السادس في مادة تصميم الخاصة بـ الفصل الأول اضغط هنا

<https://almanahj.com/ae/6design1>

* لتحميل كتب جميع المواد في جميع الفصول للـ الصف السادس اضغط هنا

<https://almanahj.com/ae/grade6>

للحصول على جميع روابط الصفوف على تلغرام وفيسبوك من قنوات وصفحات: اضغط هنا

https://t.me/UAElinks_bot

تدريب على أسئلة الاختبار لمادة التصميم و التكنولوجيا

الفصل الدراسي الثاني 2017 - 2018 / الصف السادس (الوحدة 1 و 3)





يرجى حل الأسئلة بعد الانتهاء من مراجعة الكتاب مع التركيز على ال (Activities) و
الأسئلة في نهاية الوحدة

SECTION 1 – Matching

Match the word to the picture. Write the matching letter in the correct box.

Question (1)

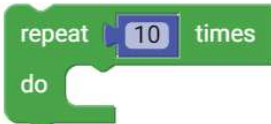
Terms



	D
	C
	E
	B
	A

Explanations

ArduBlockly	A
Output Block	B
Variable	C
Input Block	D
Iteration	E

Question (2)

Terms

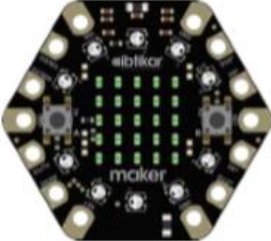
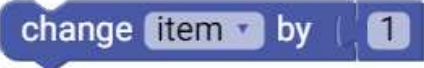

	B
	C
	A
	D

Explanations

Maker	A
Logic Block	B
Creating Variable	C
Changing Variable	D

Question (3)

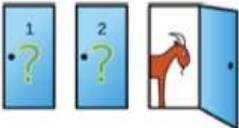
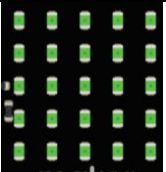
Terms

	C
	A
	D
	B











Explanations

5x5 LED screen	A
flowchart	B
conditional statement	C
Output	D

Question (4)

Write if the block used for **Input** or **Output**

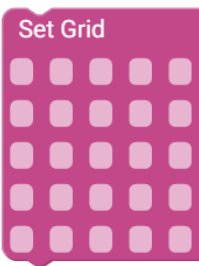
Terms

	Input
	Output
	Input
	Output
	Output
	Output
	Input
	Input
	Output
	Output
	Input

Question (5)

Terms

conditional statement	C
variables	D
logic blocks	A
programmers	B

Explanations

a block which uses decision making	A
people who write programs	B
allows the computer to choose the correct option based on a specific input	C
temporary storage in a program to store different data types	D

Question (5)

Terms

algorithm	B
starting value	A
Calculations	D
Computer programs	C

Explanations

the variable will hold each time the program starts	A
Series of instructions to solve a particular problem	B
Is instructions telling the computer how to process input and deliver output	C
Adding, subtracting, division and multiplication	D

Question (6)

Terms

CPU	F
unplugged	A
Input	D
Software	C
algorithm	E
Output	B

Explanations

Activity which does not involve electronic devices	A
Data which has been processed	B
tells the hardware what to do and in what order to do it using algorithms	C
Data which requires processing	D
is a set of instructions 'tell the computer how to process input and what, if any, output to produce	E
the brain of the computer	F

Question (7)

Terms

Inputs	C
The processor	A
Outputs	D
The memory	B

Explanations

a small chip inside the computer	A
how the computer remembers things	B
how a computer takes in information from the world	C
how a computer displays or communicates information	D

SECTION 2 – Multiple Choice Questions

Choose and circle the correct answer.

1. A program written in plain English which is very close to actual code

- A) pseudocode
- B) C++
- C) Java

2. _____ is a temporary storage in a program to store different data types

- A) Input
- B) Block
- C) variable

3. It is important to give your variables _____

- A) a big value
- B) a starting value
- C) an ending value

4. We will use a _____ to upload the program into the maker

- A) HDMI cable
- B) Serial cable
- C) USB cable

5. CPU stands for _____

- A) central processing unit
- B) controlling unit of processing
- C) control processing unit

6. The brain of the maker is _____

- A) CPU
- B) RAM
- C) Sensor

7. RAM stands for _____

- A) regular access memory
- B) repeating access memory
- C) random access memory

8. _____ is the long term memory

- A) Storage
- B) RAM
- C) The processor

9. A collection of instructions to complete a specific task is

- _____
- A) a program
 - B) an event
 - C) an application

10. What does LED stand for?

- A) Loop Entire Document
- B) Light Emitting Diode
- C) Little Emersion Display

11. Converting a program so it can be understood by a computer is called:

- A) conversion
- B) compiling
- C) completion

12. In programming, what is an action done by a user called?

- A) Task
- B) Code
- C) Event

13. What can help you remember what a block of code does?

- A) Comments
- B) Buttons
- C) Tasks

14. _____ is when a code repeats itself.

- A) Input
- B) Pseudocode
- C) Iteration

15. What does a logic block do?

- A) Store data
- B) Create variables
- C) Make decisions**

What does a variables block do?

- A) store data**
- B) Repeat code
- C) Make decisions

SECTION 3 – True or False

Choose and circle the correct answer TRUE or FALSE.

1. Iteration is a process of repeating something over and over again TRUE
2. The maker has the 4x4 LED screen for providing output FALSE
3. Computer programs are instructions telling the computer how to deliver input and process output FALSE
4. You must delete files from the Maker before you copy another one onto. FALSE
5. The Maker is so lightweight and supports 2 sensors only FALSE
6. The maker has the 5x5 LED screen for providing input TRUE
7. The starting value is the value the variable will hold each time the program starts TRUE
8. Computers store information in temporary locations called variables TRUE
9. There are 2 main components that make up any computer FALSE
10. The Ibtikar Maker block-based coding environment TRUE
11. Keyboard, mouse, touchscreen, camera, microphone, game controller and scanner are computer inputs TRUE

12. Storage is the computer's short-term memory FALSE
13. There is one way to power the Maker FALSE
14. Commenting code is not good practice. FALSE
15. When you add new code, you do not need to save it. FALSE
16. RAM is the computer's short-term memory TRUE
17. Monitor/screen, headphones/speakers and printer are computer inputs FALSE
18. The Maker can hold more than one program at a time FALSE
19. The Maker is a software. FALSE
20. LED stands for Liquid Crystal Display FALSE
21. Algorithms are sets of computer instructions TRUE
22. Comments help you remember what a certain block of code does TRUE
23. The Hard Drive is the computer's long term memory TRUE

SECTION 4 – Labelling

Label the diagram with labels from the word bank below.

Question (1)

LED Grid	Push Button	Power Pad	Pin Pad	NeoPixels
----------	-------------	-----------	---------	-----------

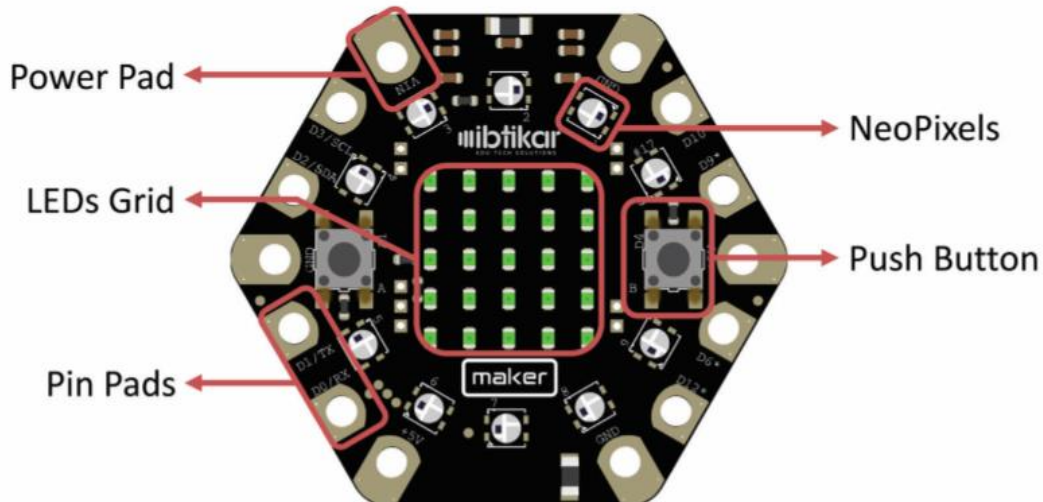

Question (2)

Accelerometer	Buzzer	Light Sensor	On-Board LED	Micro-USB Socket
Battery Connector	XBEE Sockets	Sound Sensor	Temperature Sensor	Reset Button

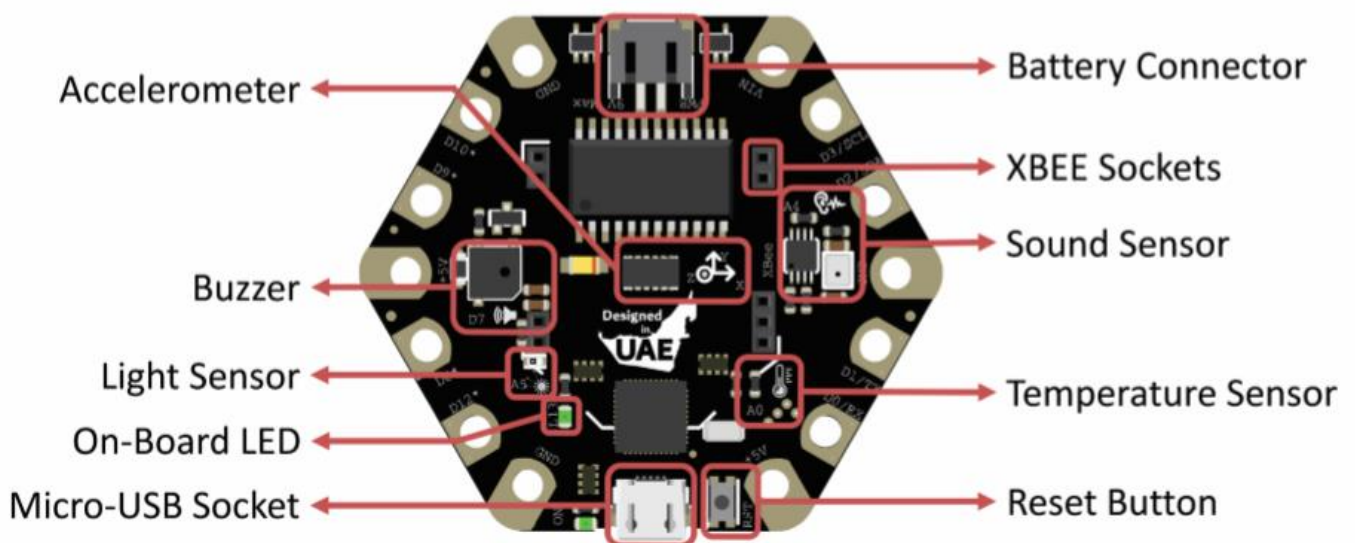

Question (3)

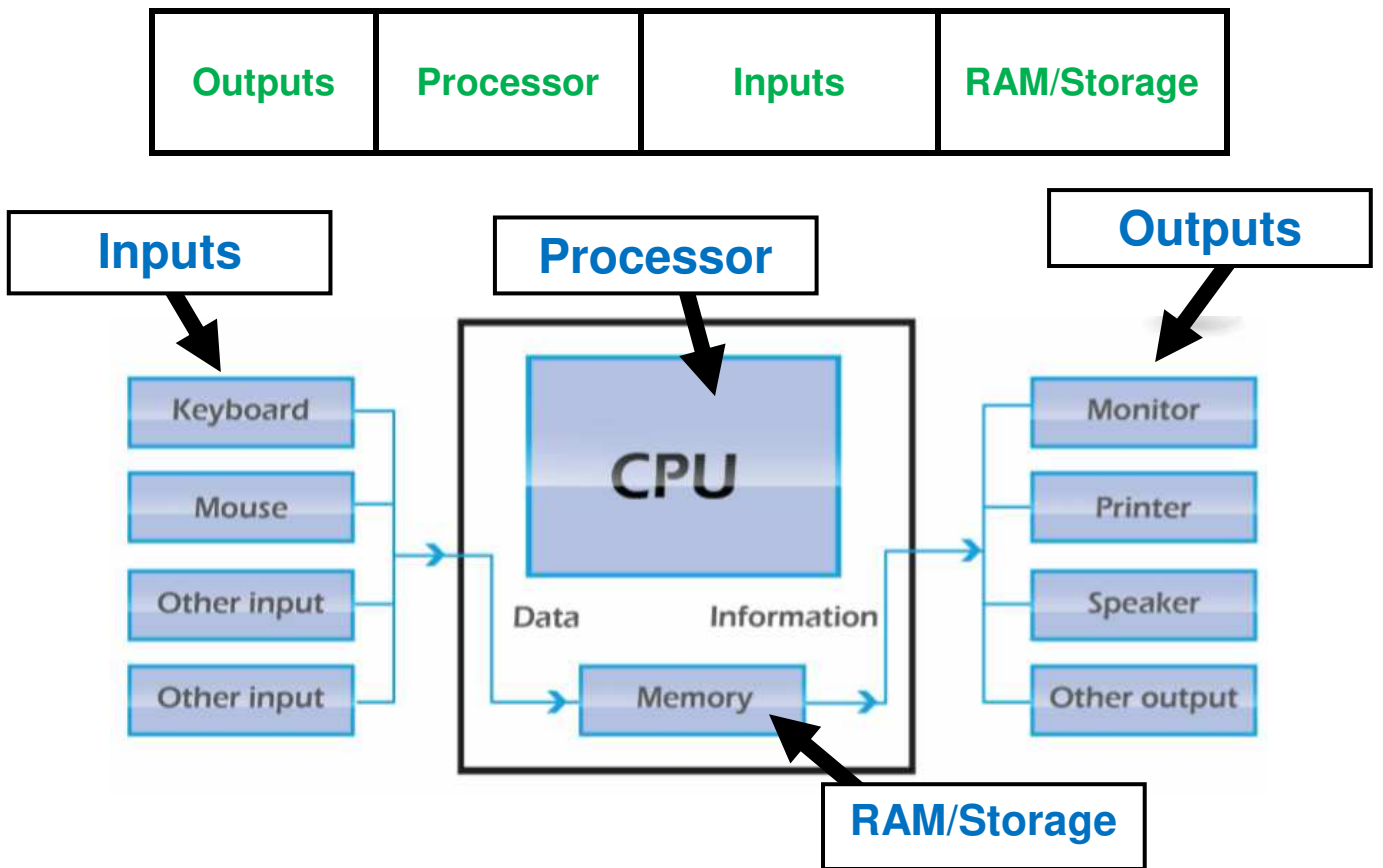

Question (4)

